



**Monza Sport.** Tough, responsive and streetwise.

First impression will probably be Monza Sport's unique appearance: a sloping front end, on-the-square twin headlights, wrap around taillights, body-color door handle inserts, and deluxe European-look finned wheel covers.

Inside, the good feeling continues, thanks to the great-looking Custom Interior with sporty vinyl or cloth-and-vinyl upholstery; brushed metal accents on steering wheel and instrument panel; handy map pockets, and more. Plus easy-sitting front bucket seats, lush cut-pile carpeting and 4-Speed manual transmission with available automatic transmission.

Monza Sport features a remarkable front-end panel of resilient urethane that resists minor bumps, front disc brakes, double-panel roof, flush-and-dry rocker panel and more.

**Monza.** The right combination of sportiness and economy.

Maybe it's time to get away from so-so driving, to feel a fresh surge of excitement behind the wheel. Then

do it with the 1978 Monza, a car for today's kind of driving needs.

There's a lively, contemporary mood about Monza that comes from clean, very appealing styling with new grid-patterned grille set in the squared-off front end, sophisticated black touches along doors and window frames, high-backed front bucket seats, vinyl or cloth-and-vinyl upholstery and new two-spoke steering wheel.

**Innovative engineering.**

Responsible in large part for Monza's efficiency is an insistence on self-improvement. Just because an engineering idea was good last year doesn't mean it can't be improved on this year. Like a new fuel efficient 4-cylinder engine, standard. This new 151 Cu. In. engine gives you more of the smooth, quiet and nicely responsive performance you've come to expect from Monza.

When you first see the new Chevrolet Monza, it strikes you as a car that's fun to look at, live with and drive. And it is.

# 1978 MONZA

## Monza Sport Series



Monza 2+2 Sport Hatchback Coupe



Monza Sport Coupe

## Monza Series



Monza 2+2 Hatchback Coupe



Monza Coupe



Monza 'S' Hatchback Coupe



Monza Wagon

**NOTE: Monza 'S' Hatchback Coupe and Monza Wagon Models  
Will Be Available After December 1, 1977.**

Monza Sport	Model No.	Monza	Model No.
Monza 2+2 Sport Hatchback Coupe.....	1HR07	Monza 2+2 Hatchback Coupe.....	1HM07
Monza Sport Coupe .....	1HR27	Monza Coupe .....	1HM27
		Monza 'S' Hatchback Coupe .....	1HM77
		Monza Wagon .....	1HM15
		Monza Estate Wagon .....	1HM15/YC6

## Index

New Monza Features for 1978 .....	2-3	Monza Spyder Features .....	12
Monza Features Continued for 1978 .....	4-5	Exterior Decor .....	13
Monza 2+2 Sport Hatchback Features .....	6	Interior Features .....	14-15
Monza 2+2 Hatchback Features .....	7	Color and Trim Selections .....	16-17
Monza Sport Coupe Features .....	8	Available Options .....	18-20
Monza Coupe Features .....	9	Power Teams .....	21
Monza 'S' Hatchback Features.....	10	Body/Chassis Features .....	22-23
Monza Wagon and Estate Wagon Features... 11		Dimensions/Specifications .....	24

*Also see Value Features section for additional details.*

# NEW MONZA FEATURES FOR 1978

- New standard cast iron 151 cu. in. L4 engine
- New Monza Sport and Monza series offer wider choice of models for 1978 including Coupe, Hatchback and Wagon models
- New distinctive soft fascia front-end styling with quad rectangular headlights on Monza Sport models
- New classic slope-back front-end styling with dual round headlights on Monza models
- New front and rear body colored bumper rub strips and guards on Monza Sport models (front bumper guards only on Sport Coupe)
- Black bumper rub strips on Monza series models
- White stripe tires standard on all models
- Wheel covers standard on all models
- New bright chrome steel front and rear bumpers on Monza 'S' Hatchback and Wagon models
- Choice of 14 exterior colors (7 new for '78)
- New vinyl and cloth interior trim and color choices for all models
- New color-keyed two-spoke steering wheel for modern appearance and good instrument visibility
- New convenient single loop front seat belt
- Larger diameter front stabilizer bar on Sport models
- New cloth covered thick foam headlining (except Monza Wagon and 'S' Hatchback)
- New Quiet Sound Group available
- New 3.2 Litre 196 cu. in. V6 engine available (Not available in California)
- 231 cu. in. V6 engine newly available (California and High Altitude only)

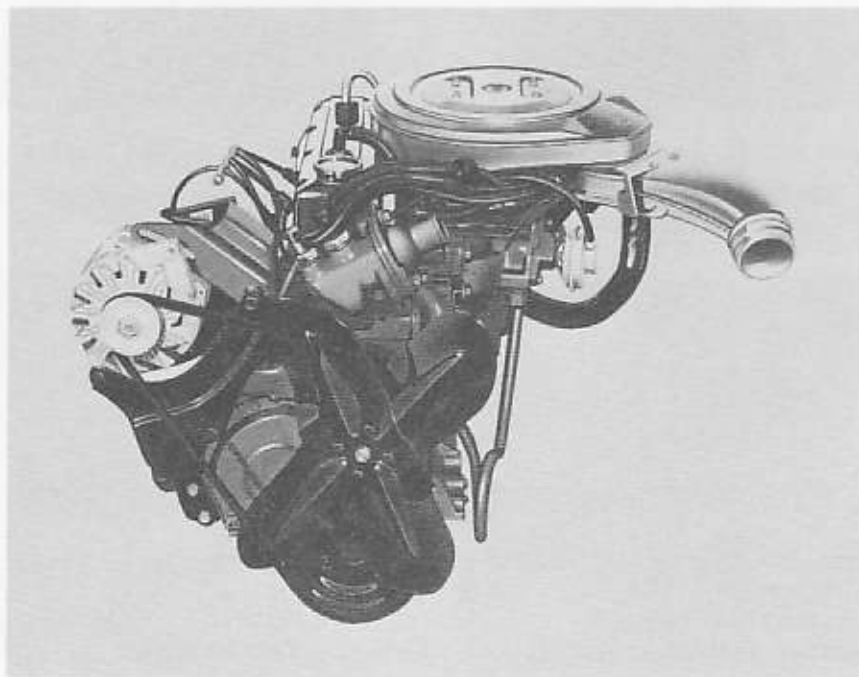

New Standard Cast Iron 151 cu. in. L4 Engine



Soft Fascia Front End with Rectangular Headlights on Monza Sport Models



Monza Slope-Back Front-End Styling with Dual Round Headlights



New Body-Colored Rub Strips and Guards on Monza Sport Models



New Color-Keyed Two-Spoke Steering Wheel



New Bright Chrome Steel Front and Rear Bumpers on Monza and Wagon Models

# STANDARD MONZA VALUE FEATURES CONTINUED FOR 1978

## **Engine/Chassis**

- 4-speed manual transmission
- Hydraulic valve lifters
- Disc/drum brake system
- Disc brake audible wear sensors
- Delcotron generator with built-in solid-state regulator
- Long recommended service intervals for oil change, oil filter, spark plugs, chassis lubrication and available automatic transmission fluid
- Integral body and frame
- Torque arm rear suspension
- Energy-absorbing bumper system
- Visible ball joint wear indicators on front suspension lower control arms
- High Energy Ignition system
- Coolant recovery system helps prevent costly coolant loss
- "Add Coolant" and "Temp/Press" warning lights on instrument panel
- Single exhaust system
- GM Specification bias ply tires
- Delco Freedom battery never needs water. Sealed side terminals help prevent corrosion buildup
- Full Coil suspension system

## **Body**

- Extensive anti-corrosion protection
- Hydropneumatic counter-balance for rear deck lid on hatchbacks
- Inner fenders front and rear for corrosion protection
- Flush-and-dry rocker panels

## **Interior**

- High-back front bucket seats
- Molded full foam seat construction
- Cut-pile passenger compartment carpeting
- Cigarette lighter
- Center dome light
- Passenger seat adjuster

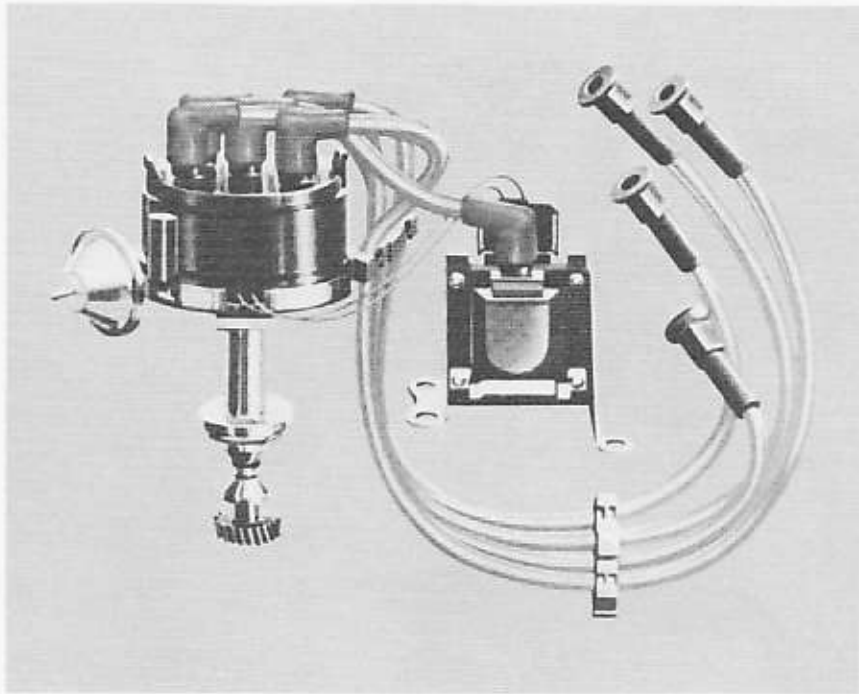

High Energy Ignition System



Delco Freedom Battery



4-Speed Manual Transmission

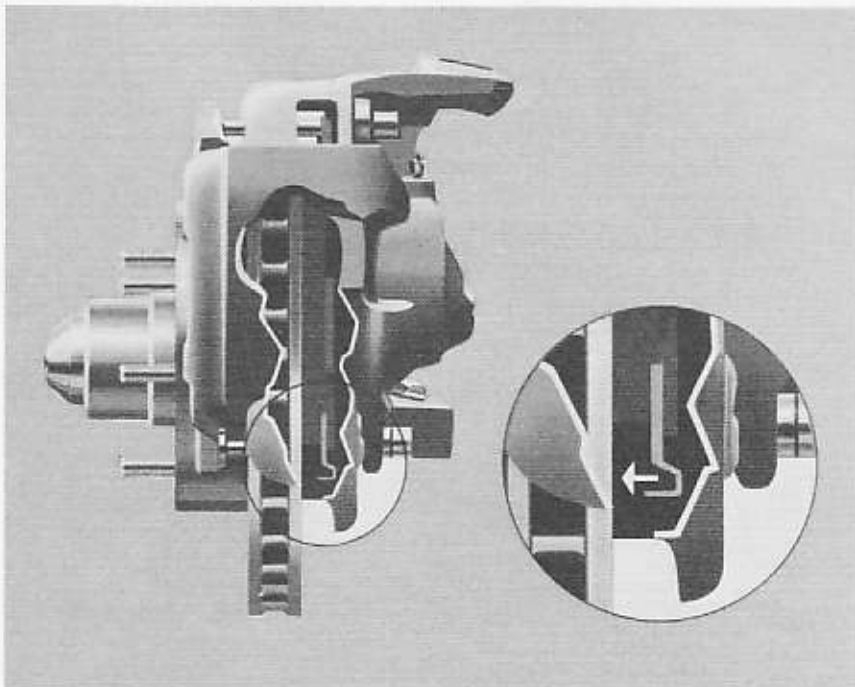

Front Disc Brake with Audible Wear Sensor

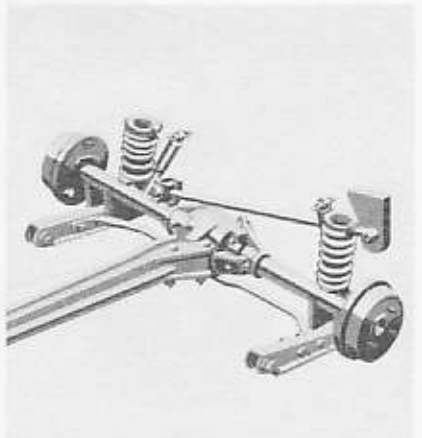

Torque Arm Rear Suspension

# MONZA

## 2+2 Sport Hatchback

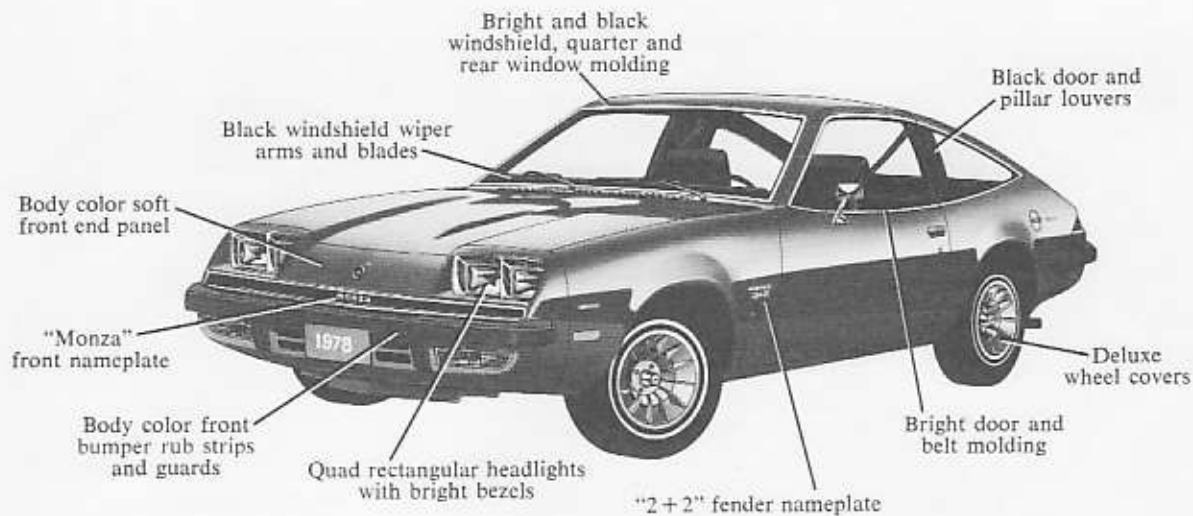

Standard  
Deluxe Wheel Covers



Available Aluminum  
Wheels (RPO N77)



Available Gold  
Styled Wheels (RPO N69)



Available Rally II  
Wheels (RPO N98)



# MONZA

## 2+2 Hatchback

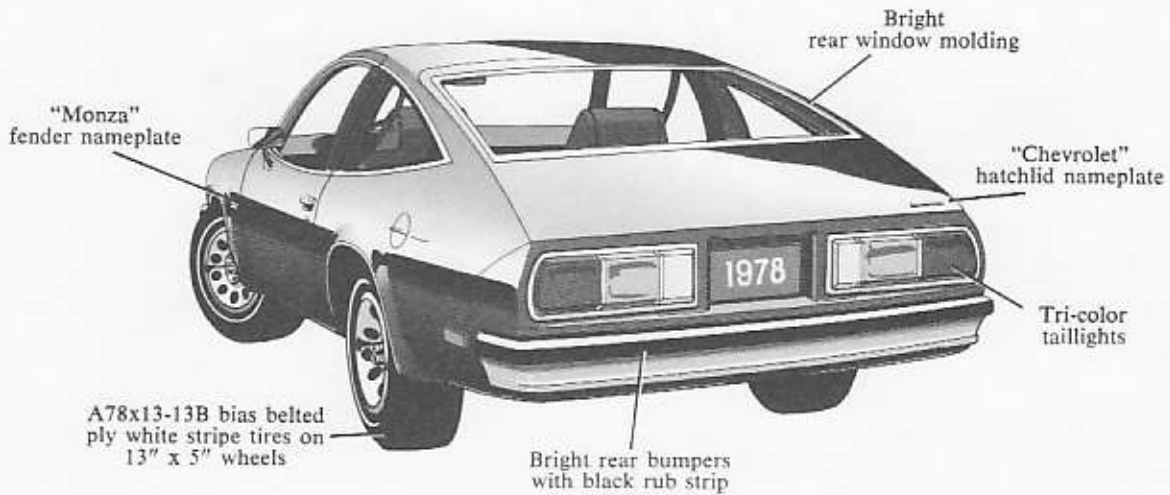

Standard full wheel cover



Available Deluxe Wheel Covers (RPO PA3)



Available Aluminum Wheels (RPO N77)



Available Gold Styled Wheels (RPO N69)



Available Rally II Wheels (RPO N98)

# MONZA

## Sport Coupe

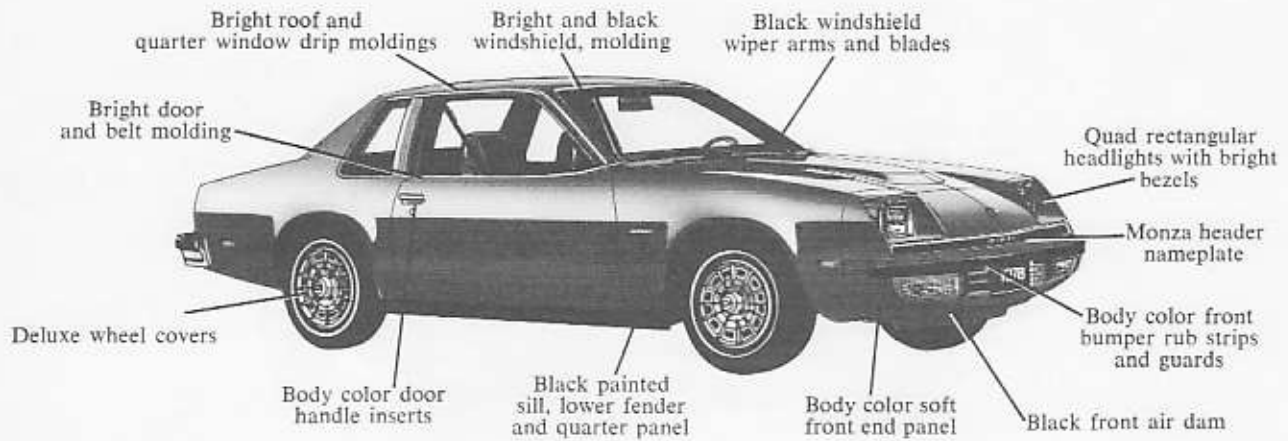

A78x13-13B bias belted ply white stripe tires on 13" x 6" wheels.



Standard  
Deluxe Wheel Covers



Available Aluminum  
Wheels (RPO N77)



Available Gold  
Styled Wheels (RPO N69)



Available Rally II  
Wheels (RPO N98)

# MONZA

## Coupe

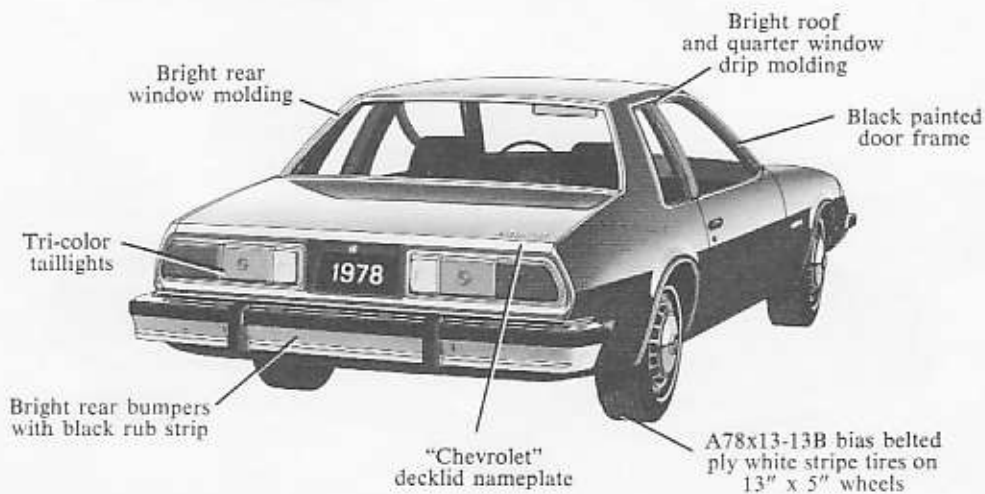
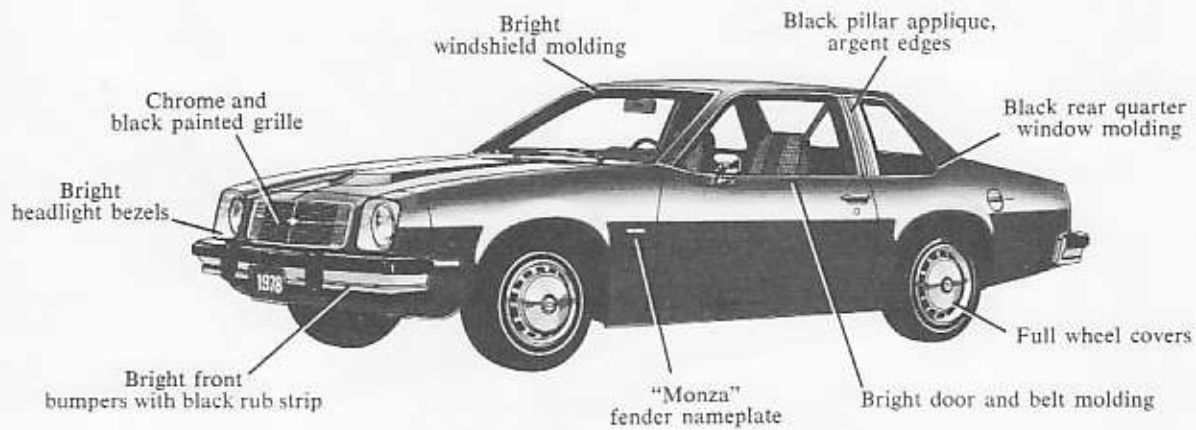

Standard full wheel cover



Available Deluxe Wheel Covers (RPO PA3)



Available Aluminum Wheels (RPO N77)



Available Gold Styled Wheels (RPO N69)



Available Rally II Wheels (RPO N98)

# MONZA

## "S" Hatchback

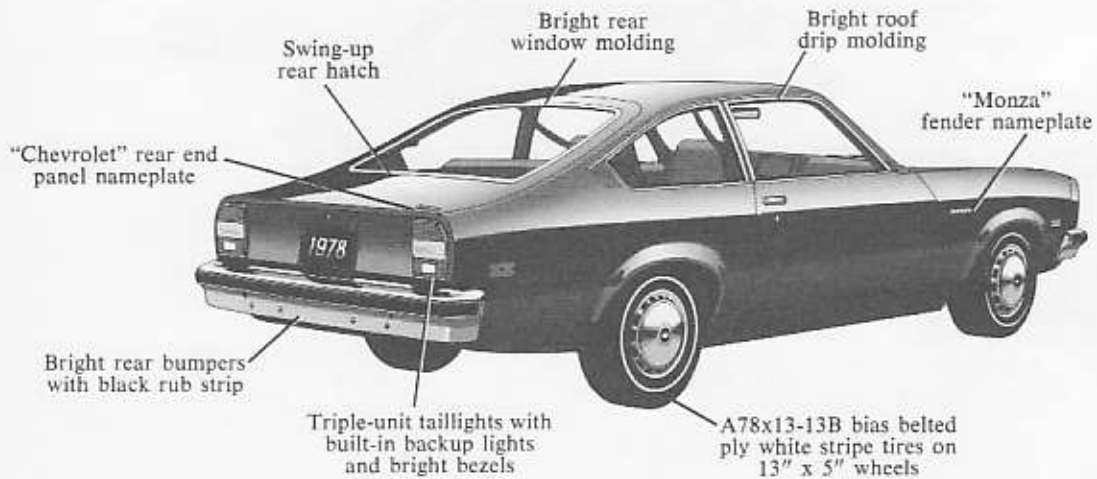

Standard full wheel cover



Available Deluxe Wheel Covers (RPO PA3)



Available Aluminum Wheels (RPO N77)



Available Gold Styled Wheels (RPO N69)



Available Rally II Wheels (RPO N98)

# MONZA

## Wagon

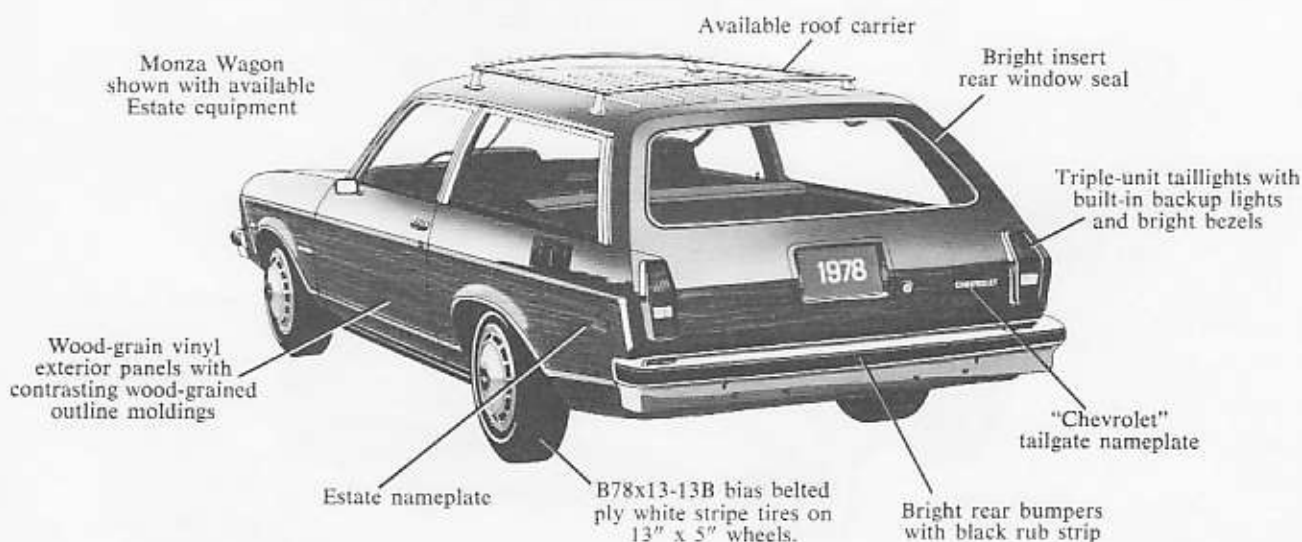

Standard Full Wheel Cover



Available Deluxe Wheel Covers (RPO PA3)



Available Aluminum Wheels (RPO N77)



Available Gold Styled Wheels (RPO N69)



Available Rally II Wheels (RPO N98)

# MONZA SPYDER

## 2+2 Sport Hatchback

2+2 Sport Hatchback equipped with available Spyder Equipment (RPO Z01) and Spyder Appearance Package (RPO Z02). See options page 18 for interior features included and other details.



Standard Rally II  
Wheels



Available Gold Styled  
Wheels (RPO N69)

# EXTERIOR DECOR

## Body Side Moldings (RPO B84)

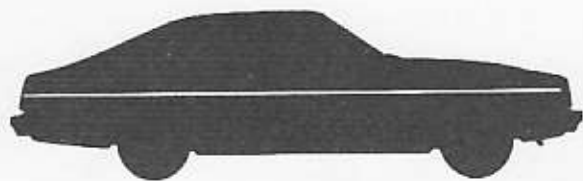
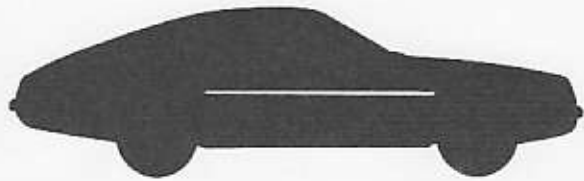

Bright with black vinyl insert. Available for all models except Estate Wagon. Monza 'S' and Wagon model moldings extend full length of body.

## Vinyl Roof Cover

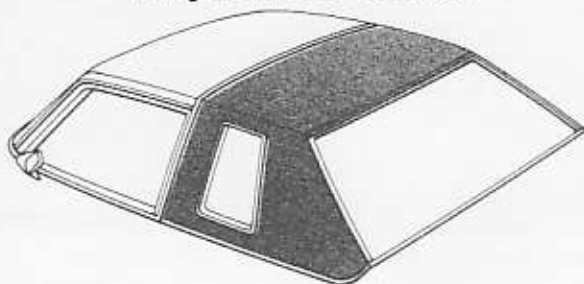

Partial roof cover for Monza Sport Coupe (1HR27) and Monza Coupe (1HM27). Available in Levant grain vinyl in seven colors.

## Spyder Striping & Lettering Colors (Included in RPO Z02)



Dual striping on body sides, plus black body sills and glass outline moldings. Multi-color Spyder decal on hood. Black or gold striping with multi-color Spyder lettering color-keyed to fourteen exterior colors. Wheels are black.

### VINYL ROOF COVER COLORS

Vinyl Roof	Code	Exterior Color Availability	
Black	BB	Rec: 11, 15, 19, 24, 51, 61 or 67	Acc: 22, 44, 48, 63, 75 or 77
Blue, Light (Metallic)	DD	Rec: 11 or 22	Acc: 19 or 24
Camel, Light	CC	Rec: 61, 63 or 69	Acc: 11, 19, 48 or 67
Carmine, Dark (Metallic)	RR	Rec:	Acc: 77
Green, Light (Metallic)	GG	Rec: 11, 44 or 48	Acc: 19
Silver	QQ	Rec: 15 or 19	Acc: 75 or 77
White	WW	Rec: All except 15, 61, 69 or 75	Acc: 15, 61, 69 or 75

Rec = Recommended      Acc = Acceptable

### SPYDER STRIPING & LETTERING COLORS

Exterior Color	Color Code		Stripe Color	Letter Color
	Lower Body	Upper Body	Body Side	Body Side/Rear Spoiler
Black	19	19	Gold	White
Blue, Bright (Metallic)	24	24	Black	White
Blue-Green, Dark (Metallic)	48	48	Gold	White
Blue, Light (Metallic)	22	22	Black	White
Camel (Metallic)	63	63	Black	White
Camel, Dark (Metallic)	69	69	Gold	White
Camel, Light	61	61	Black	Red
Carmine (Metallic)	77	77	Black	Gold
Green, Light (Metallic)	44	44	Black	White
Red, Light	75	75	Black	Gold
Saffron (Metallic)	67	67	Black	White
Silver	15	15	Black	Red
White	11	11	Black	Red
Yellow, Bright	51	51	Black	Red

See Dealer Order Guide for latest available information.

Monza/13

# INTERIOR FEATURES



Monza 2+2 Sport Hatchback Coupe, Sport Coupe  
Available Custom Cloth and Vinyl Interior



Monza Available Sport Cloth and Vinyl Interior

INTERIOR FEATURES	Monza 2+2 Sport Hatchback Monza Sport Coupe	Monza 2+2 Hatchback Monza Coupe	Monza 'S' Hatchback	Monza Wagon
Bucket seats	S	S	S	S
Deluxe bucket seats	S	EC	EC	EC
Color-keyed seat and shoulder belts	EC	EC	EC	EC
Console	EC	EC	EC	EC
Center dome light	S	S	S	S
Swing-out rear side windows	NA	NA	EC	NA
Color-keyed cut-pile carpeting	S	S	S	S
Quiet Sound Group	EC	EC	EC	EC
Body acoustical package	S	S	S	S
Passenger seat adjuster	S	S	S	S
Molded headlining	NA	NA	S	S
Cloth headlining with foam backing	S	S	NA	NA
Dual vinyl sun visors	S	S	S	S

S-Standard; NA-Not Available; EC-Extra Cost



# INSTRUMENT PANEL

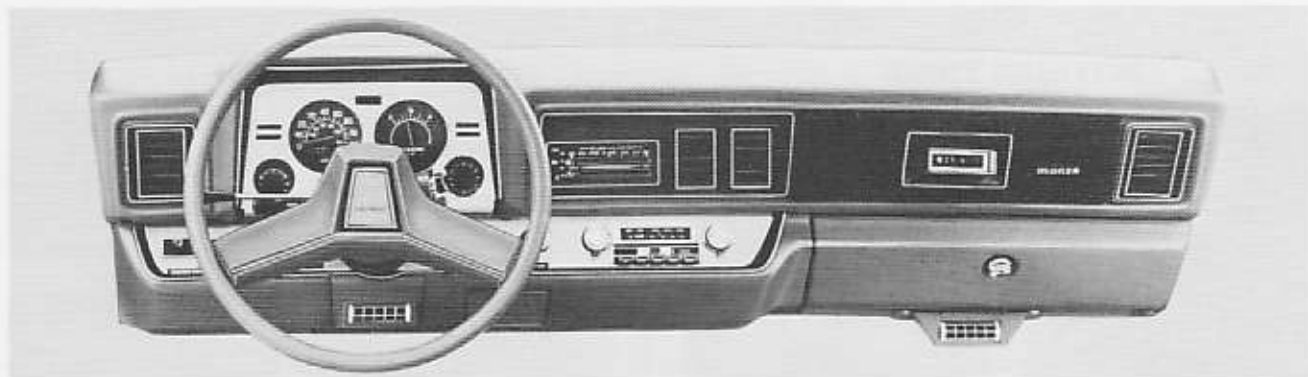

Monza 2+2 Sport Hatchback and Sport Coupe Instrument Panel

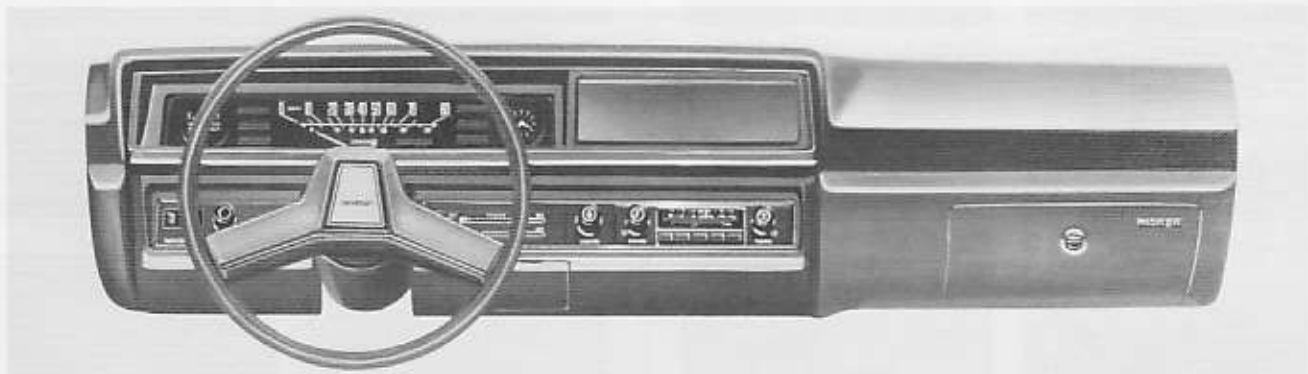

Monza 'S' Hatchback and Wagon Instrument Panel

INSTRUMENT PANEL FEATURES	Monza 2+2 Sport Hatchback Monza Sport Coupe	Monza 2+2 Hatchback Monza Coupe	Monza 'S' Hatchback	Monza Wagon
Color-keyed instrument panel	S	S	S	S
Brushed aluminum instrument panel and cluster accents	S	S	NA	NA
Color-keyed two-spoke steering wheel	S	S	S	S
Color-keyed two-spoke Sport steering wheel	EC	EC	EC	EC
Cigarette lighter	S	S	S	S
Steering column lock	S	S	S	S
Day-night rearview mirror	EC	EC	EC	EC
Digital clock	EC	EC	NA	NA
Electric clock	EC	EC	NA	NA
Glove box light	EC	EC	EC	EC
Monza instrument panel nameplate	S	S	S	S
Bright aluminum instrument panel knobs	S	S	S	S
Bright heater control levers	S	S	S	S
Audio and visual seat/shoulder and belt warning system	S	S	S	S
Center dome light	S	S	S	S
Special instrumentation	EC	EC	NA	NA
2-speed electric windshield wipers and washers	S	S	S	S
Intermittent windshield wipers	EC	EC	EC	EC

S-Standard; NA-Not Available; EC-Extra Cost

# 1978 MONZA COLOR SELECTIONS

To help you select the specific interior trim and color on your 1978 Monza model, there are four distinct trim types. A sample of each trim type, in one of the available colors, is shown below along with a list of other color selections. All 14 exterior colors are also shown.

## INTERIOR TRIMS

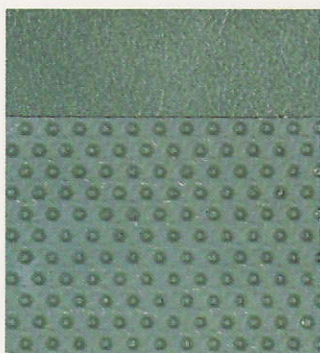

**Monza Sport and Monza Custom Interior** All-Vinyl. Black, Blue, Green (shown), Camel, Carmine, White.



**Monza** All-vinyl. Black, Blue, Camel, Carmine (shown).

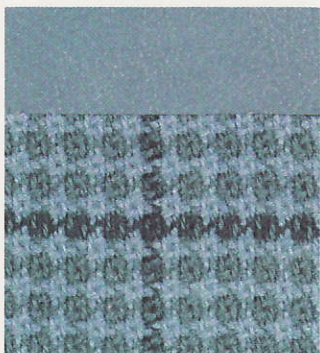

**Monza Sport and Monza Custom Interior** Sport cloth. Blue (shown), Camel, Black, Carmine.



**Monza** Sport cloth. Black, Camel (shown).

## EXTERIOR COLORS—All Models



**11**—White



**51**—Bright Yellow



**\*15**—Silver



**\*61**—Light Camel



**19**—Black

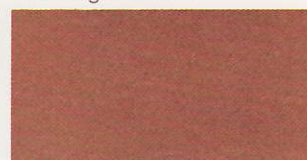

**\*63**—Camel Metallic



**22**—Light Blue Metallic



**\*67**—Saffron Metallic



**\*24**—Bright Blue Metallic



**\*69**—Dark Camel Metallic

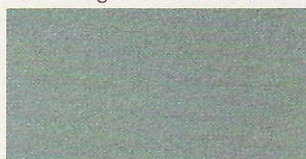

**44**—Light Green Metallic



**75**—Light Red



**48**—Dark Blue-Green Metallic



**\*77**—Carmine Metallic

\*New color for 1978

See Dealer Order Guide for latest available information.

# COLOR AND TRIM COMBINATIONS

EXTERIOR COLOR	CODE	INTERIOR COLOR													
		MONZA SPORT All models. Bucket Seats. MONZA CUSTOM INTERIOR All models. Bucket Seats.						MONZA SPORT All models. Bucket Seats. MONZA CUSTOM INTERIOR All models. Bucket Seats. Instrument panel, carpet, cowl side panel and rear shelf or load area are second color.					MONZA All models. Bucket Seats.		
		BLACK Custom Sport Cloth All-Vinyl	BLUE Custom Sport Cloth All-Vinyl	GREEN Custom Sport Cloth All-Vinyl	CAMEL Custom Sport Cloth All-Vinyl	CARMINE Custom Sport Cloth All-Vinyl	WHITE W/BLACK All-Vinyl	WHITE W/BLUE All-Vinyl	WHITE W/GREEN All-Vinyl	WHITE W/SAFFRON All-Vinyl	WHITE W/CARMINE All-Vinyl	BLACK Sport Cloth All-Vinyl	BLUE All-Vinyl	CAMEL Sport Cloth All-Vinyl	CARMINE All-Vinyl
WHITE	11	X	X	X	X	X	X	X	X	X	X	X	X	X	
SILVER	15	X	X			X	X				X	X		X	
BLACK	19	X	X	X	X	X			X	X	X	X	X	X	
LIGHT BLUE METALLIC	22	X	X				X	X			X	X			
BRIGHT BLUE METALLIC	24	X	X				X	X			X	X			
LIGHT GREEN METALLIC	44	X		X	X		X		X		X		X		
DARK BLUE-GREEN METALLIC	48	X		X	X		X		X		X		X		
BRIGHT YELLOW	51	X			X		X				X		X		
LIGHT CAMEL	61	X			X	X	X				X		X	X	
CAMEL METALLIC	63	X			X		X				X		X		
SAFFRON METALLIC	67	X			X		X		X		X		X		
DARK CAMEL METALLIC	69	X			X		X				X		X		
LIGHT RED	75	X			X	X	X				X		X	X	
CARMINE METALLIC	77	X			X	X	X			X	X		X	X	

## STANDARD INTERIOR TRIM GUIDE

- All-vinyl interior and bucket seats standard on all models.
- All other combinations are available options, including Custom Sport Cloth, Sport Cloth and Custom Interiors.

## VINYL ROOF COVERS Monza Sport HR27 and Monza HM27 Coupes



**BLACK**  
With all exteriors except 69

**BLUE\***  
With 11, 19, 22, 24 exteriors

**GREEN\***  
With 11, 19, 44, 48 exteriors

**WHITE**  
With all exteriors

**CAMEL**  
With 11, 19, 48, 61, 63, 67, 69 exteriors

**CARMINE\***  
With 77 exterior only

**SILVER\***  
With 15, 19, 75, 77 exteriors

See Dealer Order Guide for latest available information.

# AVAILABLE OPTIONS

<b>MAJOR APPEARANCE OPTIONS</b>	RPO Number	Monza 2+2 Sport Hatchback Monza Sport Coupe	Monza 2+2 Hatchback Monza Coupe	Monza 'S' Hatchback	Monza Wagon Monza Estate Wagon
<b>Spyder Appearance Package:</b> Includes black headlight openings and bezels; black parking light openings; black windshield, belt, side and rear window moldings; black painted body sill; black door and center pillar louvers; black painted rear end panel and taillight openings; body color front air dam; rear spoiler, body color with Spyder identification; Spyder emblems on front panel and rear lock cover; black sport mirrors (LH remote RH manual)—black or gold lower body side stripes with Spyder lettering outlined in red, white or gold to suit body color; Spyder hood decal; black painted Rally II wheels with bright trim rings; Spyder identification on horn button. Requires Spyder Equipment. NA with aluminum wheels or wheel opening moldings. (Available on 2+2 Sport Hatchback only)	Z02	•	NA	NA	NA
<b>Spyder Equipment:</b> Includes BR70-13 steel-belted radial ply blackwall tires; sport suspension; sport steering wheel; console; inside day/night rearview mirror; Spyder identification. Includes wheel opening moldings when Spyder Appearance Package is not ordered (Available 2+2 Sport Hatchback only)	Z01	•	NA	NA	NA
<b>APPEARANCE FEATURES</b>					
<b>Belts, Deluxe Color-Keyed Seat and Shoulder:</b> Included with Special Custom Cloth trim. NA with black or black/white interior trim	AK1	•	•	•	•
<b>Bumper Equipment:</b> Bumper guards, front and rear	V30	S	•	NA	NA
Bumper guards, front	V31	NA	NA	•	•
<b>Floor Covering:</b> Mats, color-keyed floor. Front and rear	B37	•	•	•	•
<b>Moldings:</b> Body Side (Not available on Estate)	B84	•	•	•	•
Door edge guard (Not available on Estate)	B93	•	•	•	•
Wheel opening. NA on Estate Wagon or with Spyder Appearance Package. Included with Spyder Equipment	B96	•	•	•	•
<b>Roof Cover, Cabriolet:</b> Monza Sport Coupe and Monza Coupe models only. (See Color and Trim Selections)	--	•	•	NA	NA
<b>Spoilers, Front and Rear:</b> 2+2 Sport Hatchback only. Included with Spyder Appearance Package	D80	•	NA	NA	NA
<b>Trim, Custom Interior:</b> (See Color and Trim Selections)	--	S	•	•	•
<b>Wheel Trim:</b> Aluminum Wheels.	N77	•	•	•	•
Rally II wheels. Includes trim rings. Included with Spyder Appearance Package	N98	•	•	•	•
Styled Gold Wheels (Requires radial tires)	N69	•	•	•	•
Deluxe wheel covers. NA with Aluminum Wheels or Styled Gold Wheels	PA3	S	•	•	•

NA—Not Available; S—Standard; •—Available at extra cost

	RPO Number	Monza 2+2 Sport Hatchback Monza Sport Coupe	Monza 2+2 Hatchback Monza Coupe	Monza 'S' Hatchback	Monza Wagon Monza Estate Wagon
<b>COMFORT/CONVENIENCE</b>					
Air Conditioning, Four-Season: Includes heavy-duty radiator	C60	•	•	•	•
Air Deflector, Rear Window	C51	NA	NA	NA	•
Brakes, Power	J50	•	•	•	•
Carrier, Roof	V55	NA	NA	NA	•
Clock:					
Electric. Included with Special Instrumentation	U35	•	•	NA	NA
Digital	UE8	•	•	NA	NA
Console:					
Included with Spyder Equipment	D55	•	•	•	•
Defogger, Rear Window: Electro-Clear	C49	•	•	•	•
Glass, Soft-Ray Tinted: All windows	A01	•	•	•	•
Instrumentation, Special:	U14	•	•	NA	NA
Lighting, Auxiliary: Includes: glove compartment light, underhood light, rear compartment light (wagon only) and headlight reminder buzzer	ZJ9	•	•	•	•
Mirrors:					
Inside rearview, day/night. Included with Spyder Equipment. Standard on Estate Wagon	D31	•	•	•	•
Sport, LH remote-control and RH manual. Included with Spyder Appearance Package	D35	•	•	•	•
Quiet Sound Group	BS1	•	•	•	•
Radio Equipment: (includes windshield antenna):					
AM radio	U63	•	•	•	•
AM/FM radio	U69	•	•	•	•
AM/FM stereo radio	U58	•	•	•	•
Stereo tape system with AM radio	UM1	•	•	•	•
Stereo tape system with AM/FM stereo radio	UM2	•	•	•	•
Speaker, rear seat (available only with AM radio or AM/FM radio)	U80	•	•	•	•
Windshield antenna. Included with factory-installed radios	U76	•	•	•	•
Seat Back, Adjustable Driver's Included with Estate Wagon	AN6	•	•	•	•
Seat, Rear Folding: Monza Sport Coupe and Monza Coupe only	AM7	•	•	NA	NA
Sky Roof: Manual sliding with tinted glass. NA on Monza Coupe with Cabriolet roof cover	CF4	•	•	•	NA
Steering, Power:	N41	•	•	•	•
Steering Wheels: Comfortilt. Requires power steering with V6 or V8 engines	N33	•	•	•	•
Sport, Included with Spyder Equipment and Estate Wagon	N31	•	•	•	•
Windows, Swing-Out Rear Side	A20	NA	NA	•	NA
Windshield Wiper System, Intermittent	CD4	•	•	•	•

NA—Not Available; •—Available at extra cost

See Options Section for Additional Details and Illustrations.

Monza/19

	RPO Number	Monza 2+2 Sport Hatchback Monza Sport Coupe	Monza 2+2 Hatchback Monza Coupe	Monza 'S' Hatchback	Monza Wagon Monza Estate Wagon
<b>ENGINES/TRANSMISSIONS</b>					
<b>Emission Equipment:</b> See Power Teams for availability.					
Standard Emission system	NA2	•	•	•	•
California Emission Certification	YF5	•	•	•	•
High Altitude Emission Equipment	NA6	•	•	•	•
<b>Engines:</b>					
3.2 Litre (196 cu. in.) V6	LC9	•	•	•	•
231 cu. in. V6	LD5	•	•	•	•
305 cu. in. V8	LG3	•	•	•	NA
<b>Transmissions:</b>					
5-Speed Manual	MM5	•	•	•	•
Automatic	MX1	•	•	•	•
<b>CHASSIS/MECHANICAL</b>					
<b>Axles:</b>					
Performance ratio. Requires 151 cu. in. L4 engine	G92	•	•	•	•
Positraction	G80	•	•	•	•
<b>Battery, Heavy-Duty Freedom</b>	UA1	•	•	•	•
<b>Radiator, Heavy-Duty:</b>					
Included with air conditioning	V01	•	•	•	•
<b>Suspension, Sport:</b>					
Available only with steel-belted radial ply tires. Included with Spyder Equipment	F41	•	•	•	•
<b>Tires:</b>					
BR78-13B bias ply white stripe	QLJ	•	•	•	S
BR78-13B steel-belted radial ply blackwall. NA with 305 cu. in. V8 engine or Spyder Equipment	QBR	•	•	•	•
BR78-13B steel-belted radial ply white stripe. NA with 305 cu. in. V8 engine or Spyder Equipment	QBY	•	•	•	•
BR70-13C steel-belted radial ply blackwall. Included with Spyder Equipment	QKX	•	•	•	•
BR70-13C steel-belted radial ply white stripe. Not available with Spyder Equipment	QKY	•	•	•	•
BR70-13C steel-belted radial ply white lettered	QKZ	•	•	•	•
<b>Spare Tire, Conventional:</b>					
NA for Monza 'S' Hatchback and wagon models, or with Aluminum or Styled Gold Wheels	N68	•	•	NA	NA

NA—Not Available; S—Standard; •—Available at extra cost

# POWER TEAMS

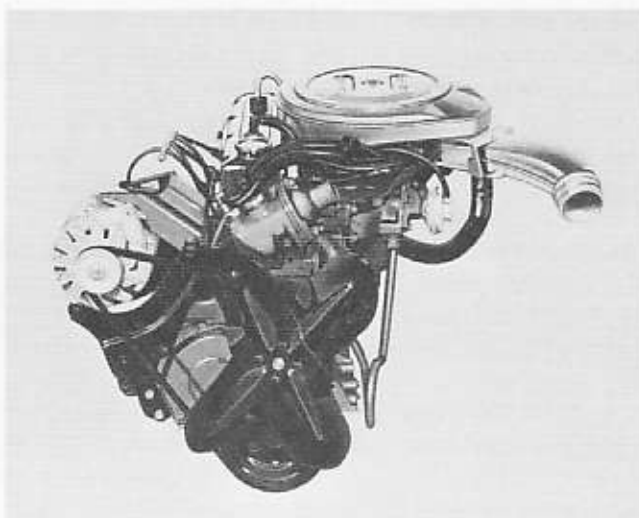

Standard Cast Iron 151 cu. in. L4 Engine

## ALL STATES EXCEPT CALIFORNIA

Engines	Power Rating†	Engine Availability		Transmissions / Rear Axle Ratios					Ring Gear Size
		All Models Except Wagons	Station Wagons	4-Speed Manual (STD.)		5-Speed Manual (RPO MM5)	Automatic (RPO MX1)		
				Below 4,000 Ft.	4,000 Ft. and Above		Below 4,000 Ft.	4,000 Ft. and Above	
151 cu. in. L4	85	STD.	STD.	2.73*	NA	3.23	2.73**	NA	7½"
3.2 Litre (196 cu. in.) V6	90	RPO LC9	RPO LC9	2.56	NA	2.73	2.73	NA	7½"
231 cu. in. V6	105▲	RPO LD5	RPO LD5	NA	2.93	NA	NA	2.93	7½"
305 cu. in. V8	145/135▲	RPO LG3	NA	3.08	NA	NA	2.29	2.56	7½"

## CALIFORNIA ONLY

151 cu. in. L4	85	STD.	STD.	NA	NA	NA	2.93	NA	7½"
231 cu. in. V6	105	RPO LD5	RPO LD5	2.93	NA	2.93	2.56	NA	7½"
305 cu. in. V8	135	RPO LG3	NA	NA	NA	NA	2.29	NA	7½"

†S.A.E. net horsepower as installed.

\*3.08 Performance Ratio available (RPO G92); included with air conditioning.

\*\*2.93 Performance Ratio available (RPO G92); included with air conditioning. ▲Rating with High Altitude Emission Equipment. STD.—Standard. NA—Not Available.

*SPECIAL NOTE: California Emission Equipment required for registration in California. In other States, High Altitude Emission Equipment may be required in areas 4,000 feet or more above sea level.*

See EPA section for mileage estimates.

# BODY/CHASSIS FEATURES

## Standard on 1978 Monza

### Body Structure & Features

- All-welded heavy-gage steel body construction with cowl, roof, underbody and body panels precision welded to form rigid body shell
- Rugged box-section-design roof rails, windshield and rear window headers, door and roof pillars
- Heavy-gage steel roof panel with double-flanged channel-crossed reinforcing bows
- High-strength double-walled cowl unit-welded to instrument panel, floor and dash panel
- Heavily ribbed and formed underbody with transverse stiffeners welded to underbody and body sills
- Flush and dry sill panels
- Hydropneumatic counter-balance for rear lid on Hatchback
- Flush-mounted windshield and rear window mounted to body
- Counterbalanced hood, deck lid
- Front and rear inner fenders for corrosion protection
- Flow-thru ventilation system
- Cushioned body mounting system effectively isolates passenger area from road noise and vibration
- Bolt-on front-end sheet metal cushion-mounted to frame and radiator support assembly
- Dual-speed electric windshield wipers
- Magic-Mirror acrylic finish

### Chassis Features

- Front disc/rear drum brake system
- Disc brake audible wear sensors
- Vented front disc brake rotors and rear brake drums for fast cooling
- Delcotron generator with built-in solid-state regulator
- High Energy Ignition system
- Coolant recovery system
- Hydraulic valve lifters
- Long recommended service intervals for oil change, oil filter, spark plugs, chassis lubrication and available automatic transmission fluid
- Visible ball joint wear indicators on front suspension lower control arms
- Delco Freedom battery never needs water. Sealed side terminals help prevent corrosion build up
- Separate front frame unit cushion-mounted to body
- Front ride stabilizer
- Torque arm rear suspension system
- Forward-mounted recirculating ball steering gear and linkage
- Full Coil suspension system
- Early Fuel Evaporation systems on all engines to hasten engine warm-up
- Tires incorporate tread wear indicator
- Direct double-acting sealed unit hydraulic shock absorbers
- A78 x 13 bias belted ply white stripe tires and 13" x 5" wheels (13" x 6" on sport models)
- B78 x 13 bias belted ply white stripe tires on Wagons



**(Information for this page will be forwarded at a later date)**

# DIMENSIONS/ SPECIFICATIONS

EXTERIOR DIMENSIONS	Monza Sport Coupe	Monza 2+2 Sport Hatchback Coupe	Monza Coupe	Monza 2+2 Hatchback Coupe	Monza 'S' Hatchback Coupe	Monza Wagon and Estate Wagon
Wheelbase	97.0	97.0	97.0	97.0	97.0	97.0
Length (overall)	178.7	179.3	178.6	178.6	177.4	177.4
Width (overall)	65.4	65.4	65.4	65.4	65.4	65.4
Height (loaded)	49.8	50.2	49.8	50.2	50.0	51.8
Tread—front	54.8	54.8	54.8	54.8	54.8	54.8
Tread—rear	53.6	53.6	53.6	53.6	53.6	53.6
Ground clearance (min.)	4.8	4.8	4.8	4.8	4.8	4.8
<b>INTERIOR ROOMINESS</b>						
Head room—front	37.6	37.7	37.6	37.7	37.0	38.5
Head room—rear	37.2	35.3	37.2	35.3	37.1	40.1
Leg room—front	42.8	42.8	42.8	42.8	42.8	42.9
Leg room—rear	28.2	29.6	28.2	29.6	30.1	30.2
Hip room—front	48.6	47.5	48.6	47.5	47.2	46.9
Hip room—rear	42.0	42.0	42.0	42.0	42.5	42.5
Shoulder room—front	51.7	51.0	51.7	51.0	51.3	51.3
Shoulder room—rear	50.8	51.2	50.8	51.2	49.2	49.2
Luggage space—effective (cu. ft.)	6.6*	10.1**	6.6*	10.1**	9.3***	46.6****
<b>CARGO COMPARTMENT</b>						
Floor length—front seat to liftgate	—	—	—	—	—	65.3
Width between wheelhouses	—	—	—	—	—	42.5
Height—floor to roof (max.)	—	—	—	—	—	28.6
Liftover height	—	—	—	—	—	22.7
Liftgate opening height	—	—	—	—	—	25.7
Liftgate opening width at belt	—	—	—	—	—	47.0
<b>RATED FUEL TANK CAPACITY (gal.)</b>						
	18.5	18.5	18.5	18.5	15.0	15.0
<b>CURB WEIGHT (pounds)</b>						
	2754	2802	2714	2756	2651	2730

\*With standard stowaway spare; 5.4 with available conventional spare

\*\*Total cargo volume 30.2 with stowaway spare; 27.8 with available conventional spare

\*\*\*With rear seat up; 26.5 with rear seat folded

\*\*\*\*With rear seat folded; 26.5 with rear seat up

# 1978 CHEVROLET

—MONZA  
—MONZA ESTATE  
—MONZA SPORT

## VEHICLE ORDERING GUIDE — MOTOR VEHICLE PRICE SCHEDULE

Description	ORDER CODE	Manufacturer's Suggested Retail Price*	List Price	Dealer Invoice Amount*	Dealer Price*
<b>MODELS</b>					
<b>85 Net HP 2.5 Litre L4/2 Engine — LX6</b>					
<b>MONZA</b>					
2 Door Coupe .....	1HM27	\$4,128.00	\$3,737.00	\$3,650.86	\$3,567.15
2 Door S Hatchback Coupe .....	1HM77	4,204.00	3,806.00	3,718.27	3,633.02
2 Door 2+2 Hatchback Coupe .....	1HM07	4,304.00	3,897.00	3,807.17	3,719.88
2 Door Station Wagon .....	1HM15	4,409.00	3,992.00	3,899.98	3,810.56
<b>MONZA ESTATE</b>					
2 Door Estate Wagon .....	1HM15/YC6	4,689.00	4,245.00	4,147.15	4,052.06
<b>MONZA SPORT</b>					
2 Door Coupe .....	1HR27	4,688.00	4,244.00	4,146.18	4,051.11
2 Door 2+2 Hatchback Coupe .....	1HR07	4,863.00	4,403.00	4,301.51	4,202.88
NOTE: 2463 mm (97") Wheelbase.					

## MODEL OPTIONS

### Custom Interior:

Includes Custom Seat, Door and Quarter Trim; Sport Steering Wheel; Right Door Courtesy Switch and Additional Acoustical Insulation. Standard on Monza Estate and Monza Sport. Custom Trim Code MUST BE SPECIFIED.

#### Monza S Hatchback Coupe:

with Custom Vinyl Trim ..... 1HM77      ZJ1      232.95      212.00      197.42      192.67  
 with Custom Cloth Trim ..... 1HM77      ZJ1      256.05      233.00      216.98      211.76

#### Monza Coupe, 2+2 Hatchback Coupe or Station Wagon:

with Custom Vinyl Trim ..... 1HM27, 1HM07, 1HM15      ZJ1      207.70      189.00      176.00      171.77  
 with Custom Cloth Trim ..... 1HM27, 1HM07, 1HM15      ZJ1      230.75      210.00      195.55      190.85

### Spyder Equipment Package:

Includes Floor Console; Sport Steering Wheel; Inside Day-Night Mirror; Wheel Opening Moldings; Sport Suspension; BR70 x 13C Steel Belted Radial Blackwall Tires and "Spyder" Identification.

Monza Sport 2+2 Hatchback Coupe ..... 1HR07      Z01      303.25      276.00      257.01      250.83

### Spyder Appearance Package:

Includes Rear Spoiler and Front Air Dam; Black Sport Mirrors; Rally II Wheels with Bright Trim Rings; Black Accent on Headlights, Parking Lights, Taillights, Windshield and Rear Window Moldings, Rear Panel, Side Door and Quarter Moldings and Lower Body; Body Side Accent Stripes with "Spyder" Identification. Spyder Equipment Package (Z01) MUST BE ORDERED.

Monza Sport 2+2 Hatchback Coupe ..... 1HR07      Z02      262.60      239.00      222.56      217.21

## POWER TEAMS

Refer to Power Teams Chart for complete availability.

### Engine: ENGINE OPTION MUST BE SPECIFIED.

Engine Description	Code	Price	Standard	Equipment	Price
2.5 Litre L4/2 (151 cid) .....	LX6		Standard Equipment		
3.2 Litre V6/2 (196 cid): "B" Range Tires MUST BE ORDERED. Not available on Monza S Hatchback Coupe, Station Wagon or Estate Wagon .....	LC9	157.15	143.00	133.16	129.96
3.8 Litre V6/2 (231 cid): "B" Range Tires MUST BE ORDERED. Monza S Hatchback Coupe or Station Wagon .....	LD5	206.60	188.00	175.07	170.86
5.0 Litre V8/2 (305 cid): BR70 x 13C Tires MUST BE ORDERED. Not available on Monza S Hatchback Coupe, Station Wagon or Estate Wagon .....	LG3	386.80	352.00	327.78	319.90

### Transmission: TRANSMISSION MUST BE SPECIFIED.

Transmission	Code	Price	Standard	Equipment	Price
4 Speed Manual .....	MM4		Standard Equipment		
5 Speed Manual .....	MM5	213.15	194.00	180.66	176.31
Automatic .....	MX1	326.35	297.00	276.57	269.92

### Optional Axle:

Optional Axle	Code	Price	Standard	Equipment	Price
Positraction .....	G80	65.95	60.00	55.87	54.53
Performance Ratio: 2.5 Litre L4/2 Engine (LX6) MUST BE ORDERED .....	G92	16.50	15.00	13.97	13.63

R - Revised

◆ NOTE: Dealer Invoice Amount includes Holdback Amount, plus any Federal Sales Tax applicable to the Holdback Amount, retained for Dealer's Account in accordance with the Vehicle Terms of Sale Bulletin.

\*Provision for Federal Sales Tax included — Federal Excise. Provincial and Municipal Taxes extra where applicable.

Prices and Specifications subject to change without notice.

**Models  
and Options  
Monza**

# 1978 CHEVROLET

VEHICLE ORDERING GUIDE — MOTOR VEHICLE PRICE SCHEDULE

Description	ORDER CODE	Manufacturer's Suggested Retail Price*	List Price	Dealer Invoice Amount*	Dealer Price*
<b>POWER ASSISTS</b>					
Brakes, Power .....	J50	\$ 80.20	\$ 73.00	\$ 67.98	\$ 66.34
Steering, Power .....	N41	162.65	148.00	137.83	134.51

## TIRES

### Monza Coupe, S Hatchback Coupe or 2+2 Hatchback Coupe:

with Stowaway Spare Tire:

			Standard	Equipment	
A78 x 13B White Stripe .....	†QAG				
B78 x 13B White Stripe .....	QLJ	17.60	16.00	14.90	14.54
BR78 x 13B Steel Belted Radial Blackwall .....	QBR	119.75	109.00	101.50	99.06
BR78 x 13B Steel Belted Radial White Stripe .....	QBY	161.55	147.00	136.89	133.60
BR70 x 13C Steel Belted Radial Blackwall .....	QKX	157.15	143.00	133.16	129.96
BR70 x 13C Steel Belted Radial White Stripe .....	QKY	200.00	182.00	169.49	165.41
BR70 x 13C Steel Belted Radial White Lettered .....	QKZ	214.25	195.00	181.59	177.22

with Conventional Spare Tire (N68):

			Standard	Equipment	
A78 x 13B White Stripe .....	†QAG				
B78 x 13B White Stripe .....	QLJ	23.10	21.00	19.56	19.09
BR78 x 13B Steel Belted Radial Blackwall .....	QBR	138.45	126.00	117.33	114.51
BR78 x 13B Steel Belted Radial White Stripe .....	QBY	191.20	174.00	162.03	158.13
BR70 x 13C Steel Belted Radial Blackwall .....	QKX	186.80	170.00	158.31	154.50
BR70 x 13C Steel Belted Radial White Stripe .....	QKY	238.45	217.00	202.07	197.21
BR70 x 13C Steel Belted Radial White Lettered .....	QKZ	257.10	234.00	217.90	212.66

Note: † -2.5 Litre L4/2 Engine (LX6) MUST BE ORDERED.

### Monza Station Wagon or Estate Wagon:

			Standard	Equipment	
B78 x 13B White Stripe .....	QLJ				
BR78 x 13B Steel Belted Radial Blackwall .....	QBR	116.45	106.00	98.70	96.33
BR78 x 13B Steel Belted Radial White Stripe .....	QBY	168.10	153.00	142.48	139.05
BR70 x 13C Steel Belted Radial Blackwall .....	QKX	163.70	149.00	138.75	135.41
BR70 x 13C Steel Belted Radial White Stripe .....	QKY	216.45	197.00	183.45	179.04
BR70 x 13C Steel Belted Radial White Lettered .....	QKZ	234.05	213.00	198.35	193.58

### Monza Sport Coupe or 2 + 2 Hatchback Coupe:

with Standard Stowaway Spare Tire except Spyder Equipment:

			Standard	Equipment	
A78 x 13B White Stripe .....	†QAG				
B78 x 13B White Stripe .....	QLJ	17.60	16.00	14.90	14.54
BR78 x 13B Steel Belted Radial Blackwall .....	QBR	76.90	70.00	65.19	63.62
BR78 x 13B Steel Belted Radial White Stripe .....	QBY	119.75	109.00	101.50	99.06
BR70 x 13C Steel Belted Radial Blackwall .....	QKX	115.40	105.00	97.78	95.43
BR70 x 13C Steel Belted Radial White Stripe .....	QKY	157.15	143.00	133.16	129.96
BR70 x 13C Steel Belted Radial White Lettered .....	QKZ	171.40	156.00	145.27	141.78

with Optional Spare Tire (N68) except Spyder Equipment:

			Standard	Equipment	
A78 x 13B White Stripe .....	†QAG				
B78 x 13B White Stripe .....	QLJ	23.10	21.00	19.56	19.09
BR78 x 13B Steel Belted Radial Blackwall .....	QBR	95.60	87.00	81.02	79.07
BR78 x 13B Steel Belted Radial White Stripe .....	QBY	148.35	135.00	125.71	122.69
BR70 x 13C Steel Belted Radial Blackwall .....	QKX	143.95	131.00	121.99	119.06
BR70 x 13C Steel Belted Radial White Stripe .....	QKY	196.70	179.00	166.69	162.68
BR70 x 13C Steel Belted Radial White Lettered .....	QKZ	215.35	196.00	182.52	178.13

Note: † -2.5 Litre L4/2 Engine (LX6) MUST BE ORDERED.

### Monza Sport 2 + 2 Hatchback Coupe (1HR07):

with Spyder Equipment and Standard Stowaway Spare Tire:

			Standard	Equipment	
BR70 x 13C Steel Belted Radial Blackwall .....	QKX				
BR70 x 13C Steel Belted Radial White Lettered .....	QKZ	57.15	52.00	48.42	47.26

with Spyder Equipment and Optional Spare Tire (N68):

BR70 x 13C Steel Belted Radial Blackwall .....	QKX	40.65	37.00	34.46	33.63
BR70 x 13C Steel Belted Radial White Lettered .....	QKZ	108.80	99.00	92.19	89.97

R - Revised

♦ NOTE: Dealer Invoice Amount includes Holdback Amount, plus any Federal Sales Tax applicable to the Holdback Amount, retained for Dealer's Account in accordance with the Vehicle Terms of Sale Bulletin.

Options  
Monza

\*Provision for Federal Sales Tax Included — Federal Excise, Provincial and Municipal Taxes extra where applicable.

Prices and Specifications subject to change without notice.

# 1978 CHEVROLET

—MONZA  
—MONZA ESTATE  
—MONZA SPORT

## VEHICLE ORDERING GUIDE — MOTOR VEHICLE PRICE SCHEDULE

Description	ORDER CODE	Manufacturer's Suggested Retail Price*	List Price	Dealer Invoice Amount*	Dealer Price*
<b>OTHER OPTIONS</b>					
<b>Air Conditioning, Four-Season:</b> includes Heavy Duty Radiator (V01) and Heavy Duty Generator, Automatic Transmission (MX1) MUST BE ORDERED when 5.0 Litre V8/2 Engine (LG3) is ordered. Variable Ratio Power Steering (N41) and Soft-Ray Tinted Glass (A01) recommended	<b>C60</b>	\$545.00	\$496.00	\$461.88	\$450.77
		Note: Federal Excise Tax extra (\$100.00).			
<b>Battery, Heavy Duty</b>	<b>UA1</b>	19.80	18.00	16.76	16.36
<b>Bells, Deluxe:</b> Color-keyed. Standard with Black Trim	<b>AK1</b>	23.10	21.00	19.56	19.09
<b>Bumper Equipment, Optional:</b> not available on Monza Sport. Front and Rear Bumper Guards: Monza	<b>1HM00</b> <b>V30</b>	46.15	42.00	39.11	38.17
<b>Carrier, Roof Luggage:</b> Supports and Upper Rails to be dealer installed. Station Wagon	<b>1HM15</b> <b>V55</b>	73.60	67.00	62.39	60.89
<b>Console, Floor:</b> included with Spyder Equipment (Z01)	<b>D55</b>	97.80	89.00	82.87	80.88
<b>Defector, Rear Window Air:</b> Station Wagon	<b>1HM15</b> <b>C51</b>	31.85	29.00	27.01	26.36
<b>Defroster, Rear Window:</b> Electro-Clear	<b>C49</b>	96.70	88.00	81.95	79.98
<b>Glass, Soft-Ray Tinted:</b> All Windows	<b>A01</b>	64.85	59.00	54.94	53.62
Windshield	<b>A02</b>	51.65	47.00	43.76	42.71
<b>Heater, Engine Block</b>	<b>K05</b>	18.70	17.00	15.83	15.45
<b>Instrumentation, Optional:</b> not available on Monza S Hatchback or Station Wagon. Clock: Dial: included with Special Instrumentation (U14) Digital Special Instrumentation: includes Tachometer, Voltmeter and Temperature Gauges. except Digital Clock (UE8): also includes Dial Clock (U35) with Digital Clock (UE8)	<b>U35</b> <b>UE8</b> <b>U14</b> <b>U14</b>	23.10 54.95 101.10 78.00	21.00 50.00 92.00 71.00	19.56 46.56 85.67 66.12	19.09 45.44 83.61 64.53
<b>Insulation Package, Quiet Sound:</b> includes extra Acoustical Insulation in all critical areas. Monza Monza Sport: Optional Engine (LC9 or LG3) MUST BE ORDERED	<b>1HM00</b> <b>1HR00</b> <b>BS1</b> <b>BS1</b>	41.75 28.55	38.00 26.00	35.39 24.21	34.54 23.63
<b>Lighting Auxiliary:</b> includes Courtesy and Underhood Lights and Headlights On Reminder. Monza Coupe, S Hatchback Coupe or 2+2 Hatchback Coupe: except Custom Interior (ZJ1): also includes Front Door Courtesy Switch with Custom Interior (ZJ1) Monza Station Wagon or Monza Estate Wagon: except Custom Interior (ZJ1) or Monza Estate (YC6): also includes Front Door Courtesy Switch and Rear Compartment Light with Custom Interior (ZJ1) or Monza Estate (YC6): also includes Rear Compartment Light Monza Sport	<b>1HM07</b> <b>1HM27, 1HM77, 1HM07</b> <b>1HM27, 1HM77, 1HM07</b> <b>1HM15</b> <b>1HM15</b> <b>1HR27, 1HR07</b> <b>ZJ9</b> <b>ZJ9</b> <b>ZJ9</b> <b>ZJ9</b> <b>ZJ9</b> <b>ZJ9</b>	26.35 19.80 40.65 34.05 19.80	24.00 18.00 37.00 31.00 18.00	22.35 16.76 34.46 28.86 16.76	21.81 16.36 33.63 28.17 16.36
<b>Mats, Color-Keyed Floor:</b> Front and Rear	<b>B37</b>	20.90	19.00	17.70	17.27
<b>Mirror, Inside Day-Night:</b> standard on Monza Estate (YC6). Included with Spyder Equipment (Z01)	<b>D31</b>	11.00	10.00	9.31	9.09
<b>Mirrors, Sport:</b> Body Color with Remote Control on Left Mirror. Included with Spyder Appearance Package (Z02)	<b>D35</b>	38.45	35.00	32.59	31.81

R - Revised

\* NOTE: Dealer Invoice Amount includes Holdback Amount, plus any Federal Sales Tax applicable to the Holdback Amount, retained for Dealer's Account in accordance with the Vehicle Terms of Sale Bulletin.

\*Provision for Federal Sales Tax Included — Federal Excise, Provincial and Municipal Taxes extra where applicable.

Prices and Specifications subject to change without notice.

Options  
Monza

# 1978 CHEVROLET

## VEHICLE ORDERING GUIDE — MOTOR VEHICLE PRICE SCHEDULE

Description	ORDER CODE	Manufacturer's Suggested Retail Price*	List Price	Dealer Invoice Amount*	Dealer Price*
<b>Moldings, Optional:</b> not available on Monza Estate (YC6) or with Woodgrain Paneling (BX3).					
Body Side Protective .....	B84	\$ 48.35	\$ 44.00	\$ 40.98	\$ 39.99
Door Edge Protective .....	B93	13.20	12.00	11.18	10.91
Wheel Opening: included with Spyder Equipment (Z01) except when Spyder Appearance Package (Z02) is ordered	B96	25.25	23.00	21.42	20.90
<b>Radiator, Heavy Duty:</b> included with Air Conditioning (C60)	V01	35.15	32.00	29.80	29.08
<b>Radio Equipment:</b>					
Pushbutton Radio with Concealed Windshield Antenna:					
AM .....	U63	90.10	82.00	76.36	74.52
AM-FM .....	U69	168.10	153.00	142.48	139.05
AM-FM Stereo with Rear Speaker (U80) .....	U58	280.20	255.00	237.46	231.75
AM with 8 Track Stereo Tape Player and Rear Speaker .....	UM1	262.60	239.00	222.56	217.21
AM-FM Stereo with 8 Track Stereo Tape Player and Rear Speaker (U80) .....	UM2	412.05	375.00	349.21	340.81
Rear Speaker: Radio U63 or U69 MUST BE ORDERED	U80	27.45	25.00	23.28	22.72
<b>Roof Cover, Cabriolet Padded:</b> Color Code MUST BE SPECIFIED. Monza Coupe or Monza Sport Coupe ..... 1HM27, 1HR27					
	CB4	184.60	168.00	156.44	152.18
<b>Roof Panel, Manual Sliding:</b> Tinted Glass (Sky Roof). Not available on Station Wagon or with Cabriolet Roof Cover (CB4) .....					
	CF4	261.50	238.00	221.63	216.30
<b>Seat Equipment, Optional:</b>					
Adjustable Driver's Seat Back: standard on Monza Estate (YC6)	AN6	23.10	21.00	19.56	19.09
Folding Rear Seat Back: standard on Monza 2+2 Hatchback Coupe and Monza Sport 2+2 Hatchback Coupe.					
Monza Coupe or Monza Sport Coupe ..... 1HM27, 1HR27	AM7	113.20	103.00	95.92	93.61
<b>Spoiler, Rear:</b> includes Front Air Dam. Included with Spyder Appearance Package (Z02).					
Monza Sport 2+2 Hatchback Coupe ..... 1HR07	D80	113.20	103.00	95.92	93.61
<b>Steering Wheel, Optional:</b>					
Sport: standard on Monza Estate (YC6). Included with Custom Interior (ZJ1) or Spyder Equipment (Z01)	N31	19.80	18.00	16.76	16.36
Comfortilt; Variable Ratio Power Steering (N41) MUST BE ORDERED when Optional Engine (LC9 or LG3) is ordered ..	N33	75.80	69.00	64.26	62.71
<b>Suspension, Sport:</b> includes Rear Stabilizer Bar. Included with Spyder Equipment (Z01). Steel Belted Radial Tires MUST BE ORDERED .....					
	F41	36.25	33.00	30.73	29.99
<b>Tire, Conventional Spare:</b> standard on Monza S Hatchback Coupe and Station Wagon. Not available with Optional Wheels .....					
	N68		No Additional Charge		
<b>Trim, Optional Interior:</b> Vinyl Trim is Standard. Refer to page 1 for Custom Interior (ZJ1).					
Optional Cloth Trim .....	—	23.10	21.00	19.56	19.09
<b>Wheel Equipment, Optional:</b>					
Monza (1HM00):					
Full Wheel Covers .....	P02		Standard Equipment		
Deluxe Wheel Covers (Color-Keyed) .....	•PA3	45.05	41.00	38.18	37.26
Rally II Wheels with Trim Rings (4) .....	N98	96.70	88.00	81.95	79.98
Aluminum Wheels (4) .....	•N77	312.05	284.00	264.46	258.10
•Note: not available on Monza Estate (1HM15/YC6).					
Monza Sport (1HR00):					
Deluxe Wheel Covers (Silver Accent) .....	—		Standard Equipment		
Deluxe Wheel Covers (Color-Keyed) .....	PA3	12.10	11.00	10.25	10.00
Rally II Wheels with Trim Rings: included with Spyder Appearance Package (Z02) .....	N98	52.75	48.00	44.70	43.62
Aluminum Wheels (4):					
except Spyder Appearance Package (Z02) .....	N77	268.10	244.00	227.22	221.75
with Spyder Appearance Package (Z02) .....	N77	215.35	196.00	182.52	178.13
<b>Windows, Swing-Out Rear Side:</b>					
Monza S Hatchback Coupe ..... 1HM77	A20	51.65	47.00	43.76	42.71
<b>Windshield Wiper System, Intermittent .....</b>					
	CD4	36.25	33.00	30.73	29.99
<b>Woodgrain Paneling:</b> standard on Monza Estate (YC6).					
Station Wagon ..... 1HM15	BX3	201.10	183.00	170.41	166.31
<b>Oshawa Delivery:</b> Gasoline and Windshield Washer Fluid .....					
	A1E	—	—	8.00	8.00

R - Revised

♦ NOTE: Dealer Invoice Amount includes Holdback Amount, plus any Federal Sales Tax applicable to the Holdback Amount, retained for Dealer's Account in accordance with the Vehicle Terms of Sale Bulletin.

### Options

\*Provision for Federal Sales Tax Included — Federal Excise, Provincial and Municipal Taxes extra where applicable.

### Monza

Prices and Specifications subject to change without notice.